

Mounting systems for solar technology

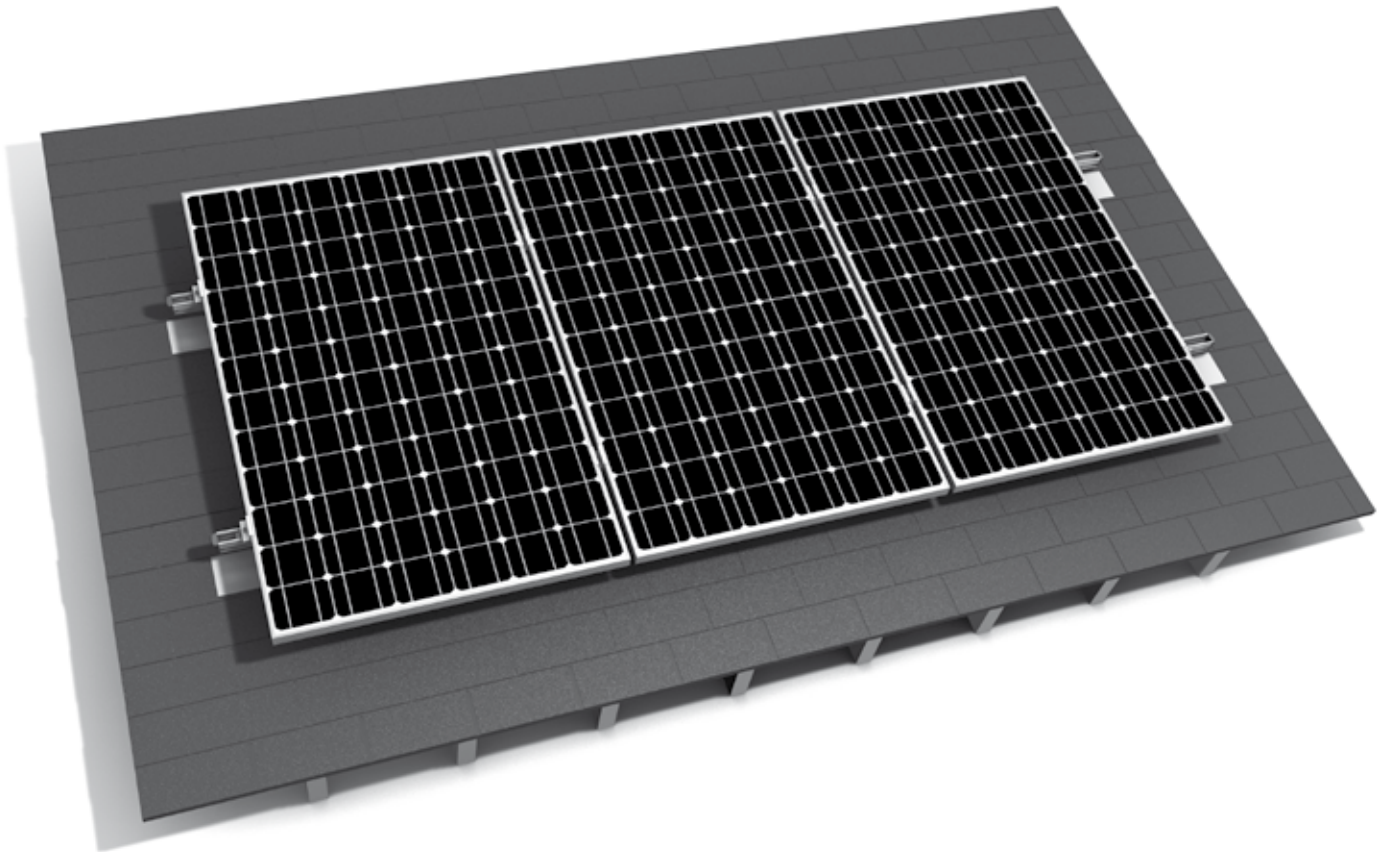

ASSEMBLY INSTRUCTIONS
RESIDENTIAL ROOF SOLUTIONS
CROSSRAIL SYSTEM

USA

TABLE OF CONTENTS

TABLE OF CONTENTS	2
THE COMPANY	3
SAFETY REGULATIONS	4
MATERIALS REQUIRED	5
TOOLS REQUIRED	7
ASSEMBLY	8
TERMS AND CONDITIONS	12

ENGINEERING STRENGTH IS AT OUR CORE

With sophisticated product innovations and a deep customer focus, Everest Solar is the engineering leader for all your mounting system needs. We are the US division of K2 Systems, one of Europe's market leaders with more than 2.5 GW installed.

We offer proven product solutions and innovative designs. Wind tunnel testing along with advanced structural and electrical validation that should facilitate permitting, design and installation. Our designs result in cost competitive racking systems with dedicated support that will position you to win more projects.

We partner with our customers and suppliers for the long-term. High quality materials and cutting edge designs provide a durable, yet functional system. Our product line is comprised of a few, coordinated components that lower the cost of materials, and simplify installation, saving you time and money. All backed by German engineering, a long track record of quality, and a company that is here to stay.

Thank you for choosing Everest Solar mountings systems for your Solar PV Project.

GENERAL SAFETY INSTRUCTIONS

Everest Solar Systems' General Assembly Instructions must be followed to maintain the exclusive, limited product warranty.

You can access these instructions at Everest Technical Info Page









<http://www.everest-solarsystems.com/us/downloads/technical-information.html> or by contacting us directly.

In general, the following applies:

- Systems should be installed by experienced contractors licensed and qualified to perform the work with professional workmanship and quality.
- Before installation, Contractor must verify that the system meets all applicable laws, regulations, ordinances, and codes. Contractor shall verify that the roof or other structures to which the system is being attached are capable of carrying the system loads. For information about the dead loads of the various system components, Contractor should review the Everest Technical information page at <http://www.everest-solarsystems.com/us/downloads/technical-information.html> or contact us directly
- Contractor is solely responsible for work safety and accident prevention regulations and corresponding standards and regulations of the applicable occupational safety and health agency are followed, including:
 - Safety clothing is worn such as safety helmets, work shoes, and gloves.
 - Where required, the contractor should use fall protection, scaffolding with arrestor equipment and other approved methods for worker safety
- Contractor shall verify that it is using the most current instructions by downloading the latest version from our website or contacting our office directly.
- Module manufacturer installation guides must be followed. Please use approved electrical bonding and grounding components that are required by the local or national codes and AHJ.
- A copy of these instructions must be on site, and read and understood by all workers during installation
- In the event our general installation and assembly instructions are not followed, or that not all system components and assemblies are used according to these instructions, or that components are used which were not obtained from us, Everest Solar Systems is not liable for any resulting defects and damages, and the exclusive, limited warranty will be void.
- The exclusive, limited product warranty shall apply only if all instructions are strictly adhered to and the system is correctly installed. Everest Solar Systems disclaims any and all warranties, express or implied, including without limitation any warranties of merchantability and fitness for a particular purpose other than as set forth in the exclusive, limited warranty in the terms and conditions of sale, which can be viewed under on our website: <http://www.everest-solarsystems.com/us/downloads/technical-information.html>
- The dismantling of the system should be in reverse order of these assembly instructions.

ESSENTIAL: THE MATERIALS REQUIRED

Below is a reference for the parts required to assemble the Everest CrossRail system. Exact quantities are based on your project requirements.

	Code compliant flashing compatible to the relevant roof with appropriate fastening fixtures e.g. QuickMount PV	
	L-Foot Material: stainless steel	1006523
	T-Bolt 28/15 M10x30 Material: stainless steel	1006039
	Alternatively: T-Bolt 20/12 M8x20 for CrossRail 36	1002387
	Self-locking nut M10x Material: stainless steel, drive: SW 15	1000042
	Alternatively: M8x for CrossRail 36	1000043
	CrossRail 48 Material: Aluminium	item number system-specific
	Alternatively: CrossRail 36	
	Rail Connector Set CrossRail 48 Material: aluminium	1002392
	Alternatively: Rail Connector Set CrossRail 36	1002389
	Module End Clamp Set Standard Material: aluminium	Item number system-specific
	Module Middle Clamp Set Standard Material: aluminium	Item number system specific

ADDITIONAL MATERIALS FOR CROSS BRACING

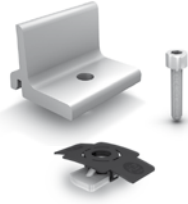

Climber Set 62/90

| 1006042

Material: stainless steel, plastic

OPTIONAL MATERIALS



End Cap for CrossRail 48

| 1004768

Material: glass fibre reinforced polyamid

Alternatively: End Cap for CrossRail 36

| 1004767



T-Bolt 28/15 M8x20

| 1000614

For bonding with WEEB-Lug on CrossRail 48



External Omega cable clip

| 1005394

Material: polyamid, black

AT A GLANCE: OVERVIEW OF THE TOOLS

Everest Solar Systems are designed to make installation easy and fast. The basic tools required to assemble the parts are listed below as a guide.



Torque wrench

With attachment for SW 13, SW 15, HW 6



Measuring tape



Cordless screwdriver

With attachment for SW 13, SW 15, HW 6

Tools and materials for the installation of third party items such as roof attachment products, roof covering and sealing products or items used for bonding and grounding are not listed here. Please refer to the instructions of those third party products.

BONDING AND GROUNDING:



Intertek
4008029

Appropriate means of bonding and grounding are required by regulation. Everest Solar Systems meets these requirements on the CrossRail system by incorporating the Everest Solar Rail Connector Set and the successfully tested Burndy WEEB KMC and WEEB Lug 8.0. The CrossRail 48 Rail Connector Set is ETL listed to UL 467, if used and installed with Everest Solar Systems racking systems as described in this manual and under the following conditions: the torque complies with the values given in this manual, non-anodized aluminum is used and the maximum conductor size of the system is AWG 6. Please continue to step 4 of this manual for instructions to install the Rail Connector. Refer to the Burndy Installation Manual to review how the WEEB KMC and WEEB Lug 8.0 are to be used in conjunction with the Everest Solar CrossRail system. The Burndy Installation Manual is available on our website:

<http://www.everest-solarsystems.com/us/downloads/technical-information.html>

ASSEMBLY: STEP BY STEP

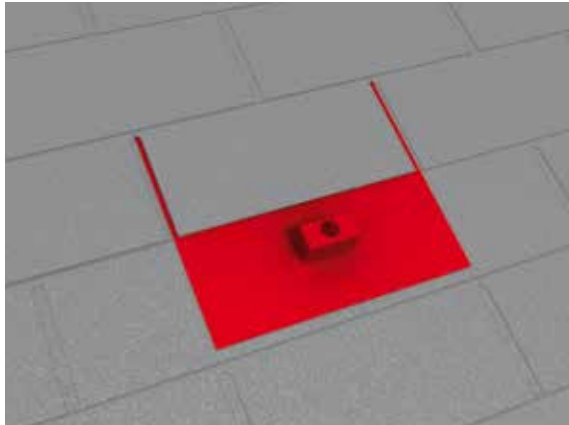

1
of 8

INSTALLATION OF THE ROOF ATTACHMENT

Select and install the chosen and appropriate roof attachment product according to the manufacturers' instructions e.g. Quickmount PV Composition mount. Usually a connection to the roof structure e.g. the rafters is necessary. Ensure the waterproofness of the roof observing all applicable laws, regulations, ordinances and codes. Make sure the attachments points are in the right position according to your structural calculations for the CrossRail system.

Materials required: appropriate roof attachment product

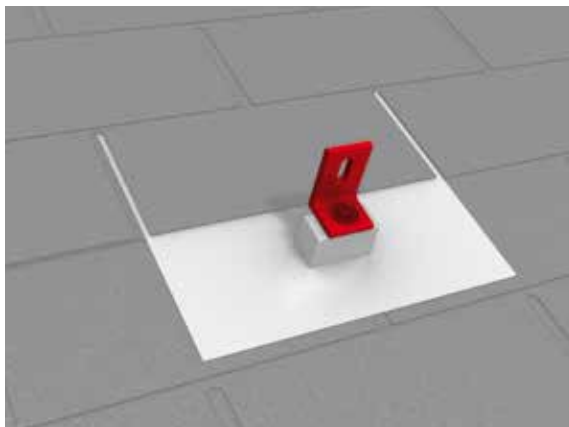

2
of 8

L-FOOT INSTALLATION

Place the L-Foot on top of the roof attachment with the long leg of the foot facing the roof ridge and tighten the attachment fixtures according to the manufacturer's instructions through the round hole of the L-Foot. Materials required: Everest L-Foot, attachment fixtures by 3rd party roof attachment supplier.

Materials required: Everest L-Foot, attachment fixtures by 3rd party roof attachment supplier.

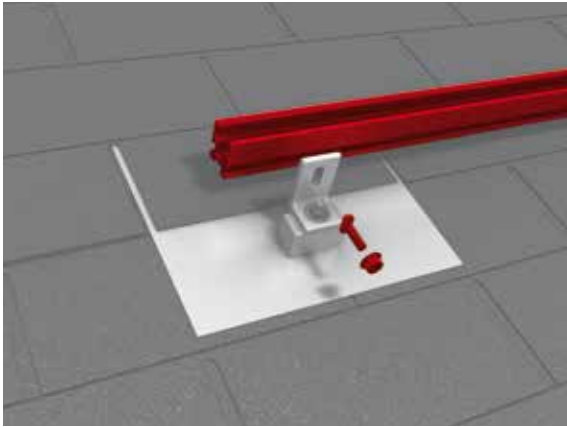

3
of 8

CROSSRAIL INSTALLATION

Place the CrossRail on the side of the L-Foot facing the roof ridge. Insert the T-Bolt through the slot hole of the foot into the lateral channel of the rail. Turn the T-Bolt clockwise making sure that the groove mark on the top end of the T-bolt is upstanding. Put the appropriate self-locking nut onto the T-Bolt, adjust the height of the rail and tighten the nut with a torque wrench using a torque 25.8 lbf-ft (35Nm) for M10, 11.8 lbf-ft (16 Nm) for M8. Make sure that the top of the CrossRail is located above the top of the L-Foot. Check once more if the groove mark on the top end of the T-Bolt is upstanding. Otherwise disassemble and repeat this installation step.

Due to thermal expansion, we recommend to break the rows after (20 m), however, no further than (24.4 m). The minimum spacing for separation between the two K2 rails is 1,25" to 2" (3-5 cm).

Materials required: CrossRail, T-Bolt M8 or M10, self-locking nut M8 or M10

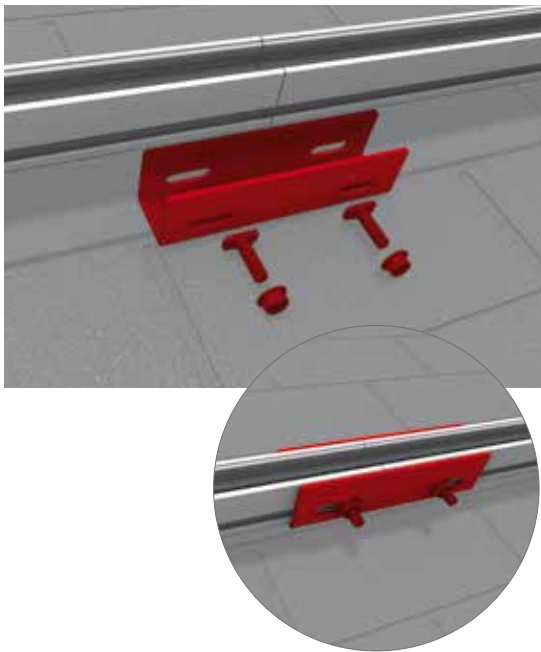

4
of 8

RAIL CONNECTOR ASSEMBLY

Align the two rail ends next to each other (Rail Joint) and slide the Rail Connector from below aligning the middle of the Rail Connector near the Rail Joint. Connect the Rail Connector to each rail using 2 T-bolts, 4 T-Bolts total, and 4 self-locking nuts. The rail joint may not be in the range of the L-Foot or roof attachment. Tightening torque: 25.8 lbf-ft (35Nm) for M10, 11.8 lbf-ft (16Nm) for M8

Materials required: Rail connector set

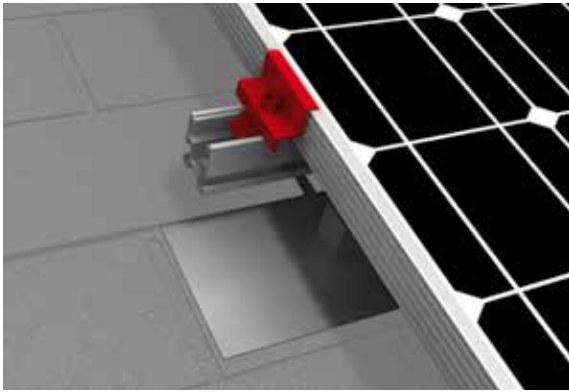

5
of 8

ATTACH MODULES

The slot nut M K2 is first inserted into the K2 CrossRail and rotated clockwise by 90 degrees. If the end clamps and middle clamps are delivered as a set, the entire set must be fixed to the rail in the same way.

Attach module to the mounting rails according to the manufacturer's instructions. Attach module at the end of each row with end clamps and Cap screws M8 as well as the slot nuts.

Never mount end clamps directly on the rail joint or end of the rail! (Spacing: min. 1" (20 mm) from end clamp). Contractor shall verify that it follows the mounting instructions of the module manufacturer!

Tightening torque 10.3 lbf-ft (14 Nm).

Materials required: End Clamp Set

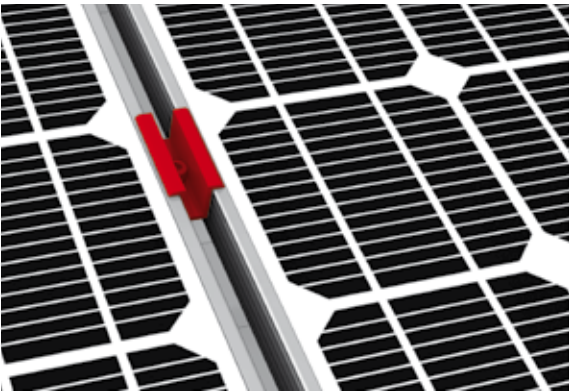

6
of 8

ATTACH MODULE GAPS

Attaching with Standard Middle Clamp

Use two standard middle clamps between two modules, which also need to be screwed with cap screws M8 in the slot nuts. Contractor shall verify that it follows the mounting instructions of the module manufacturer! Tightening torque 10.3 lbf-ft (14 Nm)

Materials required: Middle Clamp Set

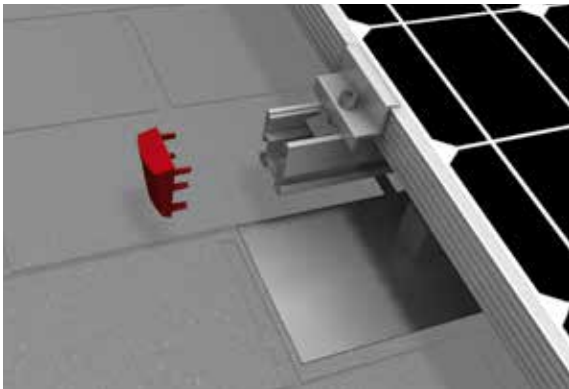

7
of 8

OPTIONAL: 7 PUT IN END CAPS

Push the pins of the appropriate end cap into end of the rail.

Materials required: end cap

ALTERNATIVE SYSTEM DESIGNS (CROSS BRACING) WITH CROSSRAIL

1
of 1

MOUNT RAILS WITH CROSS BRACING

In cross bracing, the upper rail position is fitted using the slot nut M K2 and the mounting bracket climber to the desired location, with appropriate spacing. Tightening torque 11.8 lbf-ft (16 Nm)

Materials required: CrossRail, Climber, M K2, Hexagon socket head cap screw M8, lock washer

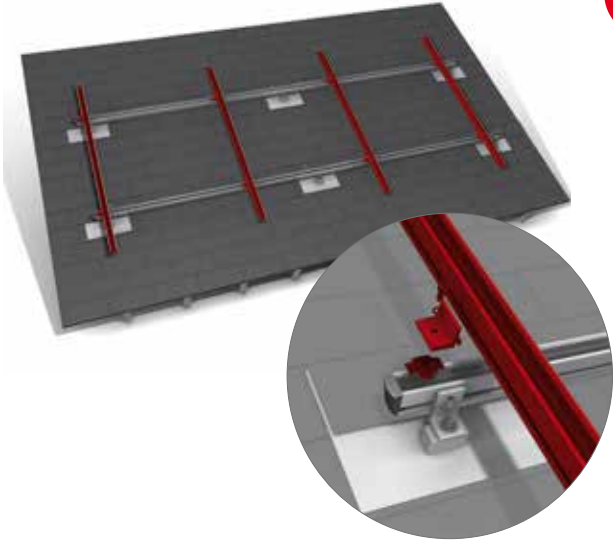

Ready!

THANK YOU FOR CHOOSING AN EVEREST SOLAR SYSTEMS MOUNTING SYSTEM.

Systems from Everest Solar Systems are fast and simple to install. Please contact us if you have any questions or suggestions for improvements. We are looking forward to receive your call on our

Service-Hotline +1 760.301.5300

TERMS AND CONDITIONS

Product images are for illustrative purposes only. Specifications are subject to change without notice. All sales of our products shall be subject to Everest Solar Systems terms and conditions, including the exclusive limited warranty set forth therein. The terms and conditions can be found at

<http://www.everest-solarsystems.com/us/downloads/technical-information.html>

Mounting systems for solar technology



Everest Solar Systems, LLC
3809 Ocean Ranch Blvd.
Suite 111
Oceanside, CA 92056
Tel. +1.760.301.5300
info@everest-solarsystems.com
www.everest-solarsystems.com

K2 Systems International:

World headquarters
K2 Systems GmbH, Germany

K2 Systems SARL, France
K2 Systems SRL, Italy
K2 Solar Mounting Solutions Ltd., UK

Montageanleitung Quickmount - CrossRail | US5 | 0713
Product images are for illustrative purposes only. Specifications are subject to change without notice. All sales of our products shall be subject to Everest Solar Systems terms and conditions, including the exclusive limited warranty set forth therein.